

HFD3-V

SUBMINIATURE SIGNAL RELAY



File No.: E133481



File No.: 40018867



File No.:CQC14002107409

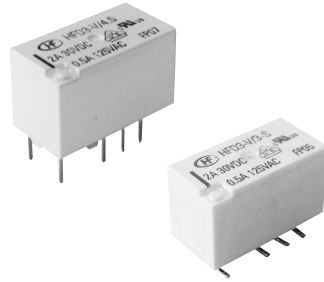

Features

- 3kV dielectric strength (between coil and contacts)
- Surge withstand voltage up to 6kV
- Meets EN60950 / EN41003
- 2 pairs of NO contacts connected in series with contact gap $\geq 1.5\text{mm}$, product in accordance to IEC60776 available.
- SMT and DIP types available
- Bifurcated contacts
- Single side stable and latching types available

RoHS compliant

CONTACT DATA

Contact arrangement	2C
Contact resistance ¹⁾	100m Ω max. (at 10mA 30mVDC)
Contact material	AgNi + Au plated
Contact rating (Res. load)	2A 30VDC 0.5A 125VAC 1A 277VAC 10mA 1000VDC
Max. switching current	4A
Max. switching voltage	1000VAC / 1500VDC (2 pairs of NO / NC contacts connected in series) 400VAC / 600VDC (1 pair of contacts)
Max. switching power	277VA / 60W
Min. applicable load ²⁾	10mV 10 μ A
Mechanical endurance	1 x 10 ⁷ OPS
Electrical endurance ³⁾	1 x 10 ⁵ OPS (0.5A 125VAC, Resistive load, AgNi + Au plated, at 85°C, 1s on 9s off)

Notes:1) The data shown above are initial values.

2) Min. applicable load is reference value. Please perform the confirmation test with the actual load before production since reference value may change according to switching frequencies, environmental conditions and expected contact resistance and reliability.

3) Electric endurance data are collected in one pair CO contact test.

CHARACTERISTICS

Insulation resistance	1000M Ω (at 500VDC)	
Dielectric strength	Between coil & contacts	3000VAC/4200VDC 1min
	Between open contacts	1500VAC/2100VDC 1min
	Between contact sets	1500VAC/2100VDC 1min
Surge withstand voltage		
Between open contacts(10/160 μ s)		2.5kV
Between coil & contacts(1.2/50 μ s)		6kV
Operate time (Set time)		6ms max.
Release time (Reset time)		6ms max.
Ambient temperature		-40°C to 85°C, -40°C to 105°C
Humidity		5% to 85% RH
Vibration resistance	Functional	10Hz to 55Hz 3.3mm DA
	Destructive	10Hz to 55Hz 5.0mm DA
Shock resistance	Functional	735m/s ²
	Destructive	980m/s ²
Termination		THT, SMT
Unit weight		Approx. 2.3g
Moisture sensitivity levels (Only for SMT type, JEDEC-STD-020)		MSL-3
Construction		Plastic sealed

Notes:1) The data shown above are initial values.

2) Specification (888) series, applicable for high-temperature environments up to 105°C.

SAFETY APPROVAL RATINGS

UL/CUL	AgNi + Au plated	2A 30VDC at 85°C
		0.5A 125VAC at 85°C 1A 277VAC at 85°C 10mA 1000VDC at 105°C
VDE	AgNi + Au plated	2A 30VDC at 85°C
		0.5A 125VAC at 85°C

Notes:1) All values unspecified are at room temperature.

2) Only typical loads are listed above. Other load specifications can be available upon request.

COIL

Coil power	Single side stable	200mW
	1 coil latching	140mW
Temperature rise		70K max.



HONGFA RELAY

ISO9001, IATF16949, ISO14001, ISO45001, IECQ QC 080000, ISO/IEC 27001 CERTIFIED

2026 Rev. 1.01

COIL DATA

at 23°C

Single side stable

Coil Code	Nominal Voltage VDC ¹⁾	Initial Pick-up Voltage VDC ¹⁾ max.	Initial Drop-out Voltage VDC min.	Coil Resistance Ω	Nominal Power mW	Max. Voltage VDC ⁵⁾
HFD3-V/1.5	1.5	1.13	0.15	11.2 x (1±10%)	200	3.0
HFD3-V/2.4	2.4	1.8	0.24	28.8 x (1±10%)	200	4.8
HFD3-V/3	3	2.25	0.3	45 x (1±10%)	200	6.0
HFD3-V/4.5	4.5	3.38	0.45	101 x (1±10%)	200	9.0
HFD3-V/5	5	3.75	0.5	125 x (1±10%)	200	10
HFD3-V/6	6	4.5	0.6	180 x (1±10%)	200	12
HFD3-V/9	9	6.75	0.9	405 x (1±10%)	200	18
HFD3-V/12	12	9	1.2	720 x (1±10%)	200	24
HFD3-V/24	24	18	2.4	2880 x (1±10%)	200	48

1 coil latching

Coil Code	Nominal Voltage VDC ¹⁾	Initial Pick-up Voltage VDC ¹⁾ max.	Initial Reset Voltage VDC ¹⁾ max.	Coil Resistance Ω	Nominal Power mW	Max. Voltage VDC ⁵⁾
HFD3-V/1.5-L1	1.5	1.13	1.13	16.1 x (1±10%)	140	3.0
HFD3-V/2.4-L1	2.4	1.8	1.8	41 x (1±10%)	140	4.8
HFD3-V/3-L1	3	2.25	2.25	64.3 x (1±10%)	140	6.0
HFD3-V/4.5-L1	4.5	3.38	3.38	145 x (1±10%)	140	9.0
HFD3-V/5-L1	5	3.75	3.75	178 x (1±10%)	140	10
HFD3-V/6-L1	6	4.5	4.5	257 x (1±10%)	140	12
HFD3-V/9-L1	9	6.75	6.75	579 x (1±10%)	140	18
HFD3-V/12-L1	12	9	9	1028 x (1±10%)	140	24
HFD3-V/24-L1	24	18	18	4114 x (1±10%)	140	48

Notes:1) The data shown above are initial values.

2) To supply rated step voltage to coil is the foundation of relay proper operation. Please make sure the applied voltage to the coil reach at rated values.

Please refer to the typical diagram below for single side stable relay. The "V_coil" is the rated voltage:

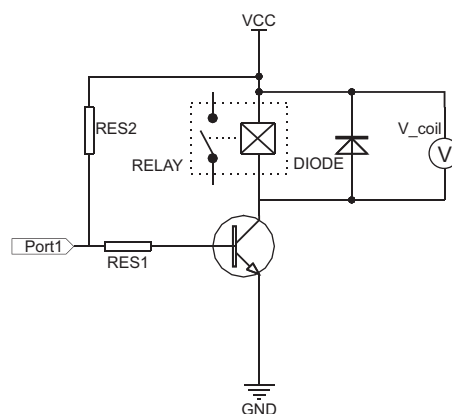

3) In case 5V of transistor drive circuit, it is recommended to use 4.5V type relay, and 3V to use 2.4V type relay.

4) For monostable relays, if you need to drop down voltage and hold mode after reliably operating, make sure that the effective value of holding voltage is not less than 60% of the rated voltage.

5) Maximum voltage refers to the maximum voltage which relay coil could endure in a short period of time.

6) When user's requirements can't be found in the above table, special order allowed.

7) During the relay pick-up or drop-out processes, there are stages of contact pressure change, contact vibration and unstable contact etc. When the voltage applied to coil is gradually changed, it will lengthen the unstable stage and affect relay endurance. To reduce this influence, please apply step voltage (switching circuit) to relay coil.

ORDERING INFORMATION

Type	HFD3-V /		24	-L1	S	R	(XXX)
Coil voltage	1.5, 2.4, 3, 4.5, 5, 6, 9, 12, 24VDC						
Sort	L1: 1 coil latching		Nil: Single side stable				
Terminal type	S: Standard SMT	S1: Short terminal SMT ¹⁾	Nil: THT ²⁾				
Packing style	R: Tape and reel packing (Only for SMT type) Nil: Tube packing(Only for THT type) ³⁾						
Special code ⁴⁾	XXX: Customer special requirement		Nil: Standard				
	825: For light load applications: testing, medical, communications, etc.						
	888: For use in 105°C high-temperature environments.						

- Notes:** 1) R type (tape and reel) packing is moisture-proof which meets requirement of MSL-3. Please choose R type packing for SMT products. For R type, the letter "R" will only be printed on packing tag but not on relay cover. Tube packing is normally not available for SMT products unless specially requested by customer. But please note that tube packing is not moisture-proof so please bake the products before use according to description of Notice 11 herewith. In addition, tube packaging will be adopted when the ordering quantity of R type is equal to or less than 100 pieces unless otherwise specified.
- 2) THT relays: Use wave or manual soldering. Confirm reflow soldering feasibility with us first.
- 3) The standard tube length is 624mm, Any special requirement needed, please contact us for more details.
- 4) The customer special requirement express as special code after evaluating by Hongfa, e.g. (131): The Dielectric strength between coil & contacts is 3000VAC 1min for single side stable and 1 coil latching version.
- 5) When coil sort, terminal type or packing style are needed, please add "-" after coil voltage is selected. For instance, HFD3-V/12-SR.
- 6) For products that should meet the explosion-proof requirements of "IEC 60079 series", please note [Ex] after the specification while placing orders. Not all products have explosion-proof certification, so please contact us if necessary, in order to select the suitable products.
- 7) Please make sure that there are no silicon-based substances (such as silicon rubber, silicone oil, silicon-based coating agents, silicon fillers, etc.) around the relay, because it will generate silicon-containing volatile gas, which may cause poor contact in case of silicon-containing volatile gas sticking on contact. Flux proofed and dust cover type relays are prohibited in environments with water vapor and harmful gases (P, Cl, H₂S, SO₂, NO₂). Plastic sealed relays shall be used with practical test verification.

OUTLINE DIMENSIONS, WIRING DIAGRAM AND PC BOARD LAYOUT

Unit: mm

Outline Dimensions

PCB Layout

(Bottom view)

THT type

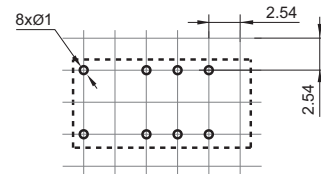
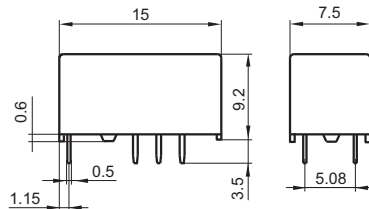

S type:
Standard SMT

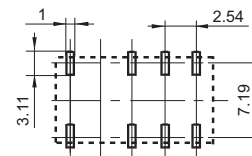
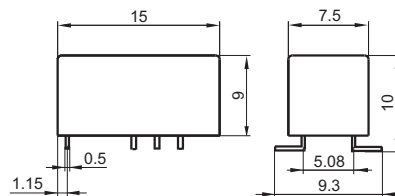

S1 type:
Short terminal SMT

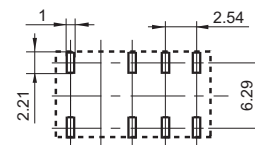
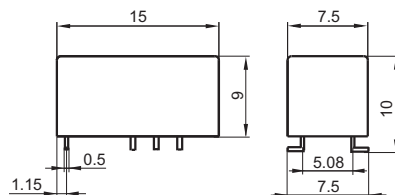

OUTLINE DIMENSIONS, WIRING DIAGRAM AND PC BOARD LAYOUT

Unit: mm

Wiring Diagram

(Bottom view)

(Please pay attention to the coil polarity. Please determine the polarity by the wiring diagram and pin diagram)

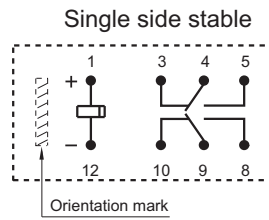

No energized condition

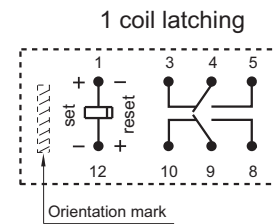

reset condition

Pin Layout

Single side stable & 1 coil latching

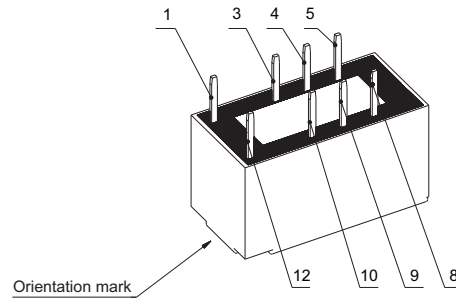

- Remark: 1) In case of no tolerance shown in outline dimension: outline dimension $\leq 1\text{mm}$, tolerance should be $\pm 0.2\text{mm}$; outline dimension $> 1\text{mm}$ and $\leq 5\text{mm}$, tolerance should be $\pm 0.3\text{mm}$; outline dimension $> 5\text{mm}$, tolerance should be $\pm 0.4\text{mm}$.
 2) The tolerance without indicating for PCB layout is always $\pm 0.1\text{mm}$.
 3) The width of the gridding is 2.54mm.

TAPE PACKING

Unit: mm

Direction of Relay Insertion

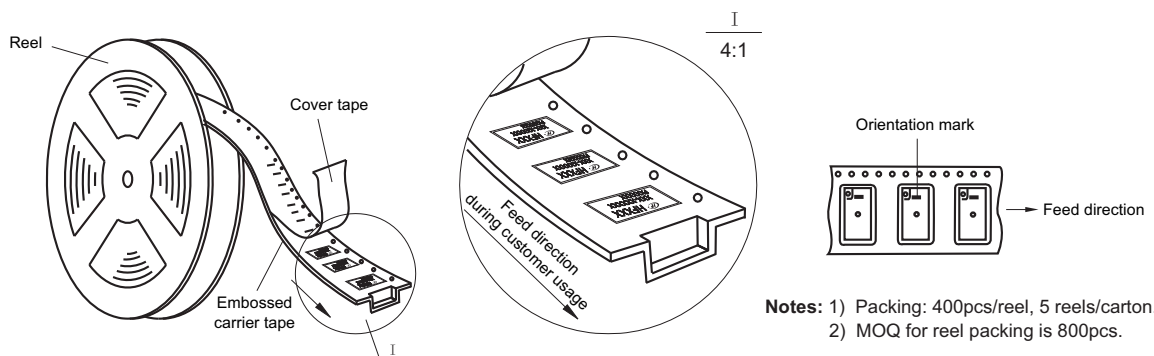

- Notes: 1) Packing: 400pcs/reel, 5 reels/carton.
 2) MOQ for reel packing is 800pcs.

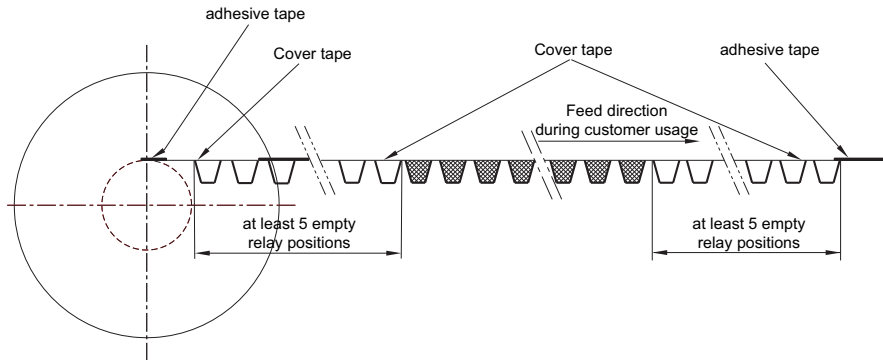

Reel Dimensions

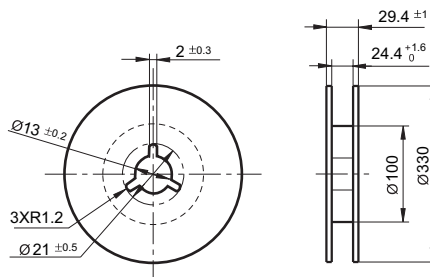

Tape Dimensions (S type: Standard SMT)

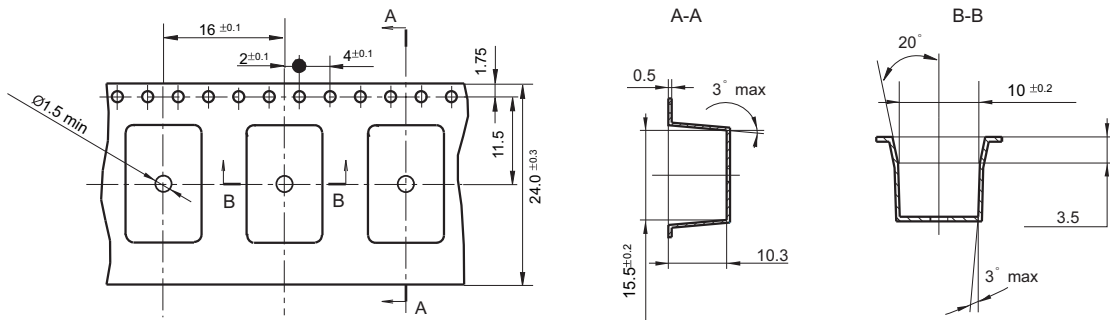

Tape Dimensions (S1 type: Short terminal SMT)

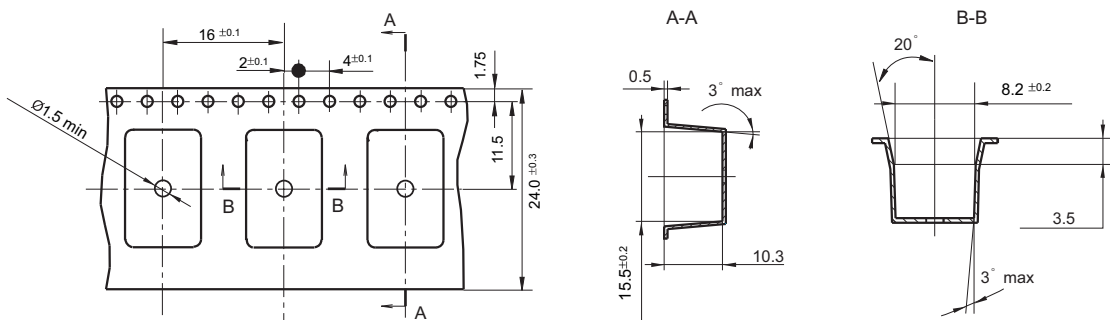

CHARACTERISTIC CURVES

MAXIMUM SWITCHING POWER

2 pairs of NO contacts connected in series

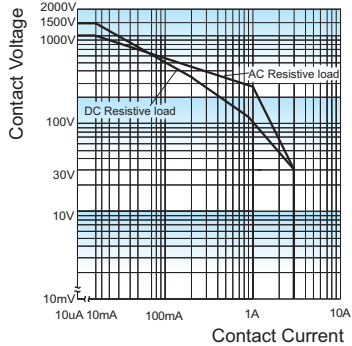

1 pair of contacts

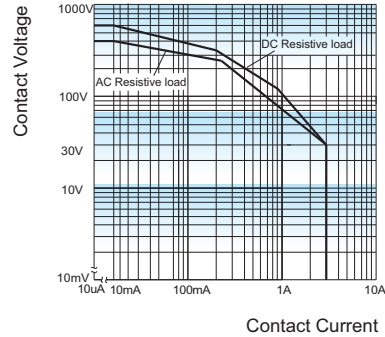

ENDURANCE CURVE

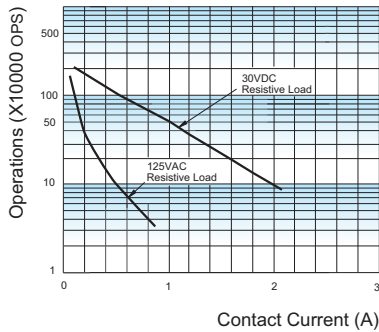

Test conditions:
Resistive load, at 85°C, 1s on 9s off.

REFLOW WELDING, TEMPERATURE ON PCB BOARD RECOMMENDED WELDING TEMPERATURE

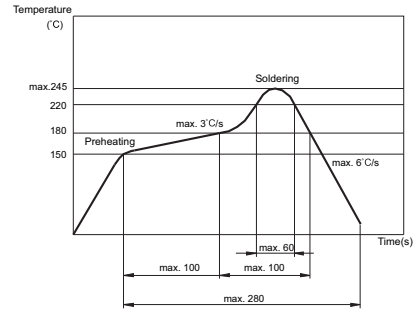

(Only for SMT type)

Notice

- 1) This relay is highly sensitive polarized relay, if correct polarity is not applied to the coil terminals, the relay does not operate properly.
- 2) To avoid using relays under strong magnetic field which will change the parameters of relays such as pick-up voltage and drop-out voltage.
- 3) Relay is on the "reset" status when being released from stock, with the consideration of shock risen from transit and relay mounting, it should be changed to the "set" status when application(connecting to the power supply). Please reset the relay to "set" or "reset" status on request.
- 4) Energizing coil with rated voltage is basic for normal operation of a relay, please make sure the energized voltage to relay coil have reached the rated voltage. Regarding latching relay, in order to maintain the "set" or "reset" status, impulse width of the rated voltage applied to coil should be more than 5 times of "set" or "reset" time.
- 5) For a monosteady state relay, after the relay is reliably operated, if it needs to be kept under pressure, make sure that the effective value of the voltage is not less than 60% of the rated voltage;
- 6) The relay may be damaged because of falling or when shocking conditions exceed the requirement.
- 7) For SMT products, validation with real application should be done before your series production, if the reflow-soldering temperature curve is out of our recommendation. Generally, two-time reflow-soldering is not recommended for the relay. However, if two-time reflow-soldering is required, a 60-min. interval should be guaranteed and a validation should be done before production.
- 8) Please use wave soldering or manual soldering for straight-in relay. If you need reflow welding, please confirm the feasibility with us.
- 9) Contact is recommended for suitable condition and specifications if water cleaning or surface process is involved in assembling relays on PCB.
- 10) Regarding the plastic sealed relay, we should leave it cooling naturally until below 40°C after welding, then clean it and deal with coating, remarkably the temperature of solvents should also be controlled below 40°C. Please avoid cleaning the relay by ultrasonic, avoid using the solvents like gasoline, Freon, and so on, which would affect the configuration of relay or influence the environment.
- 11) Relays packaged in moisture barrier bags meet MSL-3 requirements. The relays should be stored at ambient conditions of $\leq 30^\circ\text{C}$ and $\leq 60\%$ RH after they are removed from their packaging, and should be used within 168 hours. If the relays cannot be used within 168 hours, please repack them or store them in a drying oven at $25^\circ\text{C} \pm 5^\circ\text{C}$, $\leq 10\%$ RH. Otherwise, relays may be subjected to a soldering test to check their performance, or they may be used after keeping them in an oven for 72 hours at with $50^\circ\text{C} \pm 5^\circ\text{C}$, $\leq 30\%$ RH.
- 12) When applied with continuous current, the heat from relay coil will age its isolation. Thus, please do not ground connected the coil to reduce electrical erosion if possible. And please provide protection circuit to avoid broken wire and losses.
- 13) Please make sure that there are no silicon-based substances (such as silicon rubber, silicone oil, silicon-based coating agents, silicon fillers, etc.) around the relay, because it will generate silicon-containing volatile gas, which may cause poor contact in case of silicon-containing volatile gas sticking on contact. Flux proofed and dust cover type relays are prohibited in environments with water vapor and harmful gases (P, Cl, H₂S, SO₂, NO₂). Plastic sealed relays shall be used with practical test verification.
- 14) About preferable condition of operation, storage and transportation, please refer to "Explanation to terminology and guidelines of relay".
- 15) During the relay pick-up or drop-out processes, there are stages of contact pressure change, contact vibration and unstable contact etc. When the voltage applied to coil is gradually changed, it will lengthen the unstable stage and affect relay endurance. To reduce this influence, please apply step voltage (switching circuit) to relay coil.

Disclaimer

The specification is for reference only. See to "Terminology and Guidelines" for more information. Specifications subject to change without notice. We could not evaluate all the performance and all the parameters for every possible application. Thus the user should be in a right position to choose the suitable product for their own application. If there is any query, please contact Hongfa for the technical service. However, it is the user's responsibility to determine which product should be used only.

© Xiamen Hongfa Electroacoustic Co., Ltd. All rights of Hongfa are reserved.