

14FF Series

Screw press wire frame Relay Socket



Features

- Dielectric strength: C2 products can withstand up to 4000VAC, C3 products up to 5000VAC, with an insulation resistance of 1000MΩ.
- Rated current: 10A
- DIN rail or Screw mounting.
- Accessory Available: Retainer、Marker、Jumper

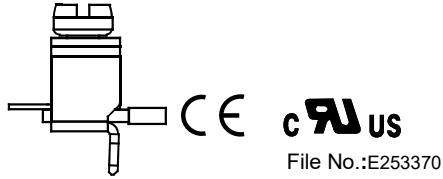

CHARACTERISTICS

Type	Nominal Voltage	Nominal Current	Ambient Temperature	Dielectric Strength min.	Screw Torque	Wire Strip Length	Unit weight	Min. package qty.
14FF-1Z-C2	250VAC/DC	10A	-40°C ~ 70°C	4000VAC 1min	0.6N·m	7mm	Approx.34g	10
14FF-1Z-C3	250VAC/DC	10A	-40°C ~ 70°C	5000VAC 1min	0.6N·m	7mm	Approx.42g	10
14FF-2Z-C2	250VAC/DC	10A	-40°C ~ 70°C	4000VAC 1min	0.6N·m	7mm	Approx.40g	10
14FF-2Z-C3	250VAC/DC	10A	-40°C ~ 70°C	5000VAC 1min	0.6N·m	7mm	Approx.47g	10

ORDERING INFORMATION

Type	14FF	-1Z	-C2	(XXX)
Contact arrangement	1Z: 1 Form C 2Z: 2 Form C			
Termination & mounting	C2/C3: Screw press wire frame			
Special code	XXX: The customer special requirement Nil: Standard type			

OUTLINE DIMENSIONS, WIRING DIAGRAM AND PC BOARD LAYOUT

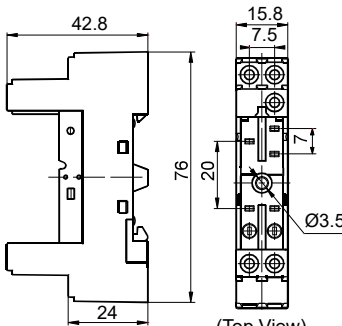
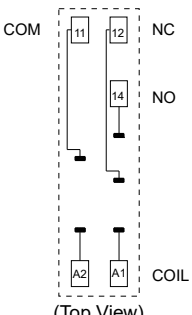
Socket (If need accessory, please order with type.)	Outline Dimensions	PCB Layout	Accessory Available
14FF-1Z-C2  Screw terminal, DIN rail or Screw mounting, With finger protection device	 (Top View)	 (Top View)	Retainer: 14FF-H4 14FF-H6 14FF-H7 14FF-H8 14FF-H10 Marker: 14FF-M1 Plug-in module: HFAA~HFHU* Jumper: 14FF-J2

Notes: If need accessory, please order with type.







HONGFA RELAY

ISO9001, IATF16949, ISO14001, ISO45001, IECQ QC 080000, ISO/IEC 27001 CERTIFIED

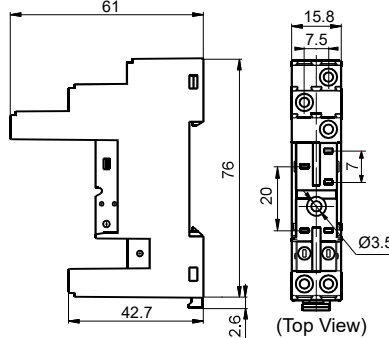
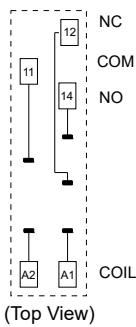
2025 Rev. 1.00

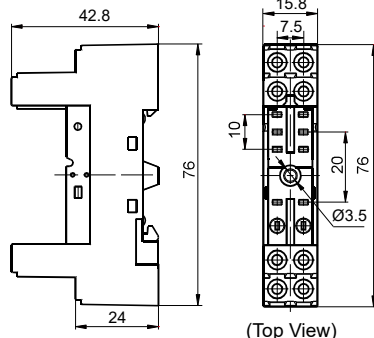
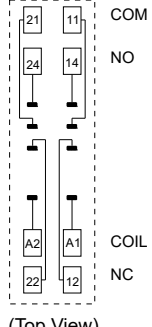
OUTLINE DIMENSIONS, WIRING DIAGRAM AND PC BOARD LAYOUT

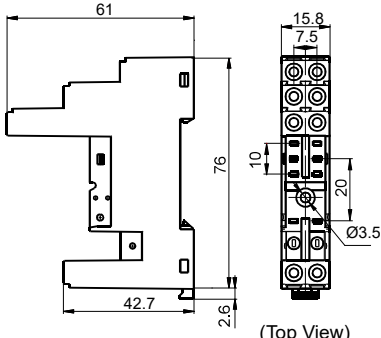
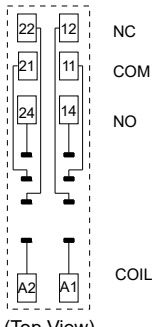
Socket (If need accessory, please order with type.)	Outline Dimensions	PCB Layout	Accessory Available
<p>14FF-1Z-C3</p>  <p>Screw Terminal, DIN rail or Screw mounting, With finger protection device Applicable for HF14FF/141F</p>	 <p style="text-align: center;">(Top View)</p>	 <p style="text-align: center;">(Top View)</p>	<p>Retainer: 14FF-H4 14FF-H6 14FF-H7 14FF-H8 14FF-H10</p> <p>Marker: 14FF-M1</p> <p>Plug-in module: HFAA~HFHU*</p> <p>Jumper: 14FF-J2</p>
<p>14FF-2Z-C2</p>  <p>Screw Terminal, DIN rail or Screw mounting, With finger protection device</p> <p>When it used with HF115F, HF115F-A, HF115FP and relay type 3, "21"-11", "24"-14", "22"-12" of socket must connect in parallel.</p>	 <p style="text-align: center;">(Top View)</p>	 <p style="text-align: center;">(Top View)</p>	<p>Retainer: 14FF-H4 14FF-H6 14FF-H7 14FF-H8 14FF-H10</p> <p>Marker: 14FF-M1</p> <p>Plug-in module: HFAA~HFHU*</p> <p>Jumper: 14FF-J2</p>
<p>14FF-2Z-C3</p>  <p>Screw Terminal, DIN rail or Screw mounting, With finger protection device</p> <p>When it used with HF115F, HF115F-A, HF115FP and relay type 3, "21"-11", "24"-14", "22"-12" of socket must connect in parallel.</p>	 <p style="text-align: center;">(Top View)</p>	 <p style="text-align: center;">(Top View)</p>	<p>Retainer: 14FF-H4 14FF-H6 14FF-H7 14FF-H8 14FF-H10</p> <p>Marker: 14FF-M1</p> <p>Plug-in module: HFAA~HFHU*</p> <p>Jumper: 14FF-J2</p>

Notes: If need accessory, please order with type.

DIMENSION OF RELATED ACCESSORY (AVAILABLE)

Unit: mm

Retainer

14FF-H4 (Plastic retainer)

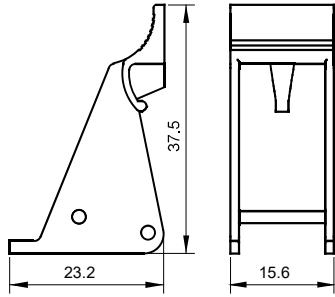

Applicable for HF115F, HF115FK, 115F-A, HF158f etc..

14FF-H6 (Plastic retainer)

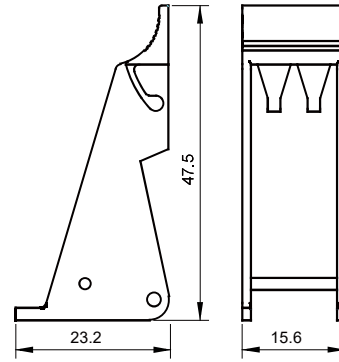

Applicable for HF115FP, HF140FF-G etc..

14FF-H7 (metallic retainer)

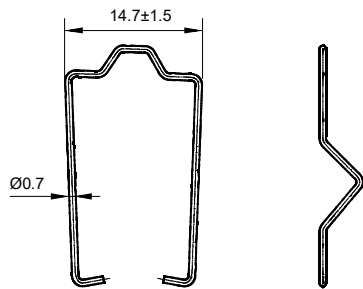

Applicable for HF115F, HF115FK, 115F-A, HF158f etc..

14FF-H8 (metallic retainer)

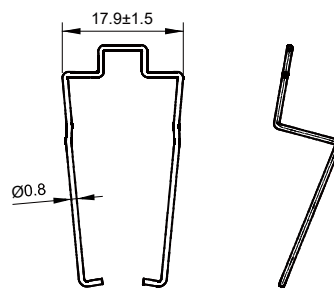

Applicable for HF115FP, HF14FW, HF140FF-G etc..

14FF-H10 (metallic retainer)

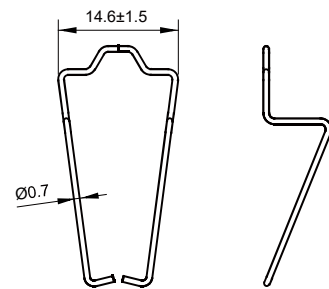

Applicable for HF158F-V etc..

Marker

14FF-M1

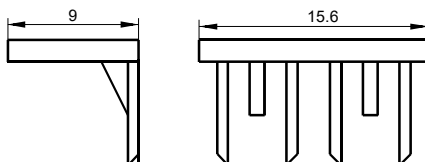

Jumper

14FF-J2

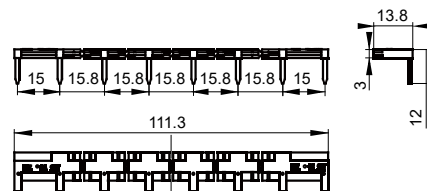

SELECTION OF PARTS

Type of Relay	Socket	Retainer	Marker	Module
HFA2/□□□-□□□□□□	14FF-2Z-A1	14FF-H11	—	—
	14FF-2Z-C2(767)	14FF-H6	14FF-M1	HFAA~HFHU
	14FF-2Z-C10			
HF115F/□□□-2□□□□□	14FF-2Z-A1	14FF-H1/H9	—	—
	14FF-2Z-C2	14FF-H4	14FF-M1	HFAA~HFHU
	14FF-2Z-C3			
	14FF-2Z-C4			
	14FF-2Z-C10			
HF115F-A/□□□-2□□□□□	14FF-2Z-A1	14FF-H1/H9	—	—
	14FF-2Z-C2	14FF-H4	14FF-M1	HFAA~HFHU
	14FF-2Z-C3			
	14FF-2Z-C4			
	14FF-2Z-C10			
HF115F/□□□-1□□3□□	14FF-2Z-A1	14FF-H1/H9	—	—
	14FF-2Z-C2	14FF-H4	14FF-M1	HFAA~HFHU
	14FF-2Z-C3			
	14FF-2Z-C4			
	14FF-2Z-C10			
HF115F-A/□□□-1□□3□□	14FF-2Z-A1	14FF-H1/H9	—	—
	14FF-2Z-C2	14FF-H4	14FF-M1	HFAA~HFHU
	14FF-2Z-C3			
	14FF-2Z-C4			
	14FF-2Z-C10			
HF115FP/□□□-□□□□	14FF-2Z-A1	14FF-H3/H11	—	—
	14FF-2Z-C3	14FF-H6	14FF-M1	HFAA~HFHU
	14FF-2Z-C4			
	14FF-2Z-C10			
HF115FK/□□-□□□□□	14FF-2Z-A1	14FF-H9	—	—
	14FF-2Z-C3	14FF-H4	14FF-M1	HFAA~HFHU
	14FF-2Z-C10			
HF158F-V/□□-H□□2T	14FF-2Z-A1	—	—	—
	14FF-2Z-C3	14FF-H10	14FF-M1	HFAA~HFHU
	14FF-2Z-C10			
HF158F/□□-□□3□	14FF-2Z-A1	14FF-H1/H9	—	—
	14FF-2Z-C3	14FF-H4	14FF-M1	HFAA~HFHU
	14FF-2Z-C10			
HF14FF/□□□-□□□□□	14FF-1Z-A1	14FF-H2	—	—
HF14FW/□□□-□□□□□	14FF-2Z-A1	14FF-H3	—	—
HF140FF-G/□□□-□□□□□	14FF-2Z-A1	14FF-H3	—	—
	14FF-2Z-C2(767)	14FF-H6	14FF-M1	HFAA~HFHU
	14FF-2Z-C10			

Things to be noticed when selecting sockets:

1. Please choose suitable relay socket according to the actual mounting environment, relay contact poles and terminal layout. If there is any query on selection, please contact Hongfa for the technical service;
2. Relevant accessories must be selected separately. Please indicate the model of the selected accessories when ordering;
3. Main outline dimension, outline dimension $>50\text{mm}$, tolerance should be $\pm 1\text{mm}$; $20\text{mm} < \text{outline dimension} \leq 50\text{mm}$, tolerance should be $\pm 0.5\text{mm}$; $5\text{mm} < \text{outline dimension} \leq 20\text{mm}$, tolerance should be $\pm 0.4\text{mm}$, outline dimension $\leq 5\text{mm}$, tolerance should be $\pm 0.3\text{mm}$;
4. DIN rail mounting: recommend to use TH 35-7.5 mounting rails compliant with IEC 60715. For non-standard rail requirements, please consult our sales department for compatibility verification;
5. Use a PH1-type screwdriver bit for terminal connections. Maximum screw torque: 0.6 N·m.

Precautions For Use

For your personal safety and the normal operation of the equipment, as well as to prevent fire, please note the following issues :

1. The rated current of the socket should be no less than the rated current of the relay.
2. Sockets are required to be firmly fixed to prevent the wiring from loosening and affecting the quality of wiring.
3. Be sure to disconnect power to the outlet before installation, disassembly, wiring, maintenance and inspection.
4. prevent foreign objects such as wire shavings from falling inside this product when wiring.
5. Be sure to install the relay in place, and use accessories such as retainer if necessary to improve contact reliability. Do not use with incomplete connections.
6. Be sure to observe the relay ratings and do not overload the relay.
7. Before selecting a relay, make sure that the drive voltage matches the relay excitation voltage.

Disclaimer

The specification is for reference only. See to "Terminology and Guidelines" for more information. Specifications subject to change without notice. We could not evaluate all the performance and all the parameters for every possible application. Thus the user should be in a right position to choose the suitable product for their own application. If there is any query, please contact Hongfa for the technical service. However, it is the user's responsibility to determine which product should be used only.

© Xiamen Hongfa Electroacoustic Co., Ltd. All rights of Hongfa are reserved.