

# HF49FD

# MINIATURE POWER RELAY



File No. : E133481



File No. : 40033644



File No. : R50149334



File No.:CQC10002049162



## Features

- 5A switching capability
- 3kV dielectric strength (between coil and contacts)
- Slim size (width 5mm, height 12.5mm)
- High sensitive: Min. 120mW
- Meets IEC61131-2 reinforce insulation
- Creepage/clearance distance: Min. 3.5mm
- Sockets available

RoHS compliant

## CONTACT DATA

Contact arrangement	1A
Contact Resistance <sup>1)</sup> (at 1A 6VDC)	No gold plated: 100mΩ max. Gold plated: 50mΩ max.
Contact material	AgSnO <sub>2</sub> , AgNi
Contact rating (Res. load)	5A 250VAC/30VDC
Max. switching voltage	250VAC /125VDC(at 0.3A)
Max. switching current	5A
Max. switching power	1250VA / 150W
Min. contact load <sup>2)</sup>	No gold plated: 5VDC 10mA Gold plated: 5VDC 1mA
Mechanical endurance <sup>3)</sup>	2 x 10 <sup>7</sup> OPS
Electrical endurance	1 x 10 <sup>5</sup> OPS (3A 250VAC/30VDC, Resistive load, AgNi, at 85°C, 1s on 9s off) 5 x 10 <sup>4</sup> OPS (5A 250VAC/30VDC, Resistive load, AgNi, Room temp., 1s on 9s off)

Notes: 1) The data shown above are initial values.

2) Min. contact load is just a reference value in normal temperature, normal humidity and normal pressure environment, which will vary depending on the power-on and off frequency, environmental conditions and expected lifespan. Thus, please have confirmation tests with actual load before use. And it is recommended to avoid using the relay when the temperature is below 0°C.

3) No loading test, no mechanical damage after the test.

## CHARACTERISTICS

Insulation resistance	1000MΩ (at 500VDC)	
Dielectric strength	Between coil & contacts	3000VAC 1min
	Between open contacts	1000VAC 1min
Surge voltage(between coil & contacts) <sup>4)</sup>	6kV (1.2 / 50μs)	
Operate time (at rated.volt.)	10ms max.	
Release time (at rated.volt.)	5ms max.	
Shock resistance	Functional	98m/s <sup>2</sup>
	Destructive	980m/s <sup>2</sup>
Vibration resistance	10Hz to 55Hz 1.5mm DA	
Humidity	5%RH to 85% RH	
Ambient temperature	-40°C to 85°C	
Termination	PCB	
Unit weight	Approx. 3g	
Construction	Plastic sealed	

Notes: 1) The data shown above are initial values.

2) Please find coil temperature curve in the characteristic curves below.

3) UL insulation system: Class F, Class B, Class A.

4) Contact refers to the mov.-contact.

## COIL

Coil power	Approx. 120mW (at 5VDC to 18VDC)
	Approx. 180mW (at 24VDC)

## COIL DATA

at 23°C

Nominal Voltage VDC	Pick-up Voltage VDC max. <sup>2)</sup>	Drop-out Voltage VDC min. <sup>2)</sup>	Max. Voltage VDC <sup>3)</sup>	Coil Resistance Ω
5	3.50	0.25	6.0	208 x (±10%)
6	4.20	0.30	7.2	300 x (±10%)
9	6.30	0.45	10.8	675 x (±10%)
12	8.40	0.60	14.4	1200 x (±10%)
18	12.6	0.90	21.6	2700 x (±15%)
24	16.8	1.20	28.8	3200 x (±15%)

Notes: 1) All above data are tested when the relays terminals are downward position. Other positions of the terminals, the pick-up and drop-out voltages will have ±5% tolerance. For example, when the relay terminals are transverse position, the max. pick-up voltage change is 75% of nominal voltage.

2) The data shown above are initial values.

3) \*Maximum voltage refers to the maximum voltage which relay coil could endure in a short period of time.

4) 24VDC 120mW type are also available, please see ordering information for more details.

## SAFETY APPROVAL RATINGS

UL/CUL	1H1 type	AgSnO <sub>2</sub>	3A 250VAC COSØ=1 at 85°C 3A 30VDC L/R =0ms at 85°C
		AgNi	5A 250VAC COSØ=1 5A 30VDC L/R =0ms
VDE	1H2 type	AgNi	3A 250VAC COSØ=1 at 85°C 3A 30VDC L/R =0ms at 85°C
		AgNi	5A 250VAC COSØ=1 5A 30VDC L/R =0ms
TÜV			5A 250VAC COSØ=1 at 85°C 5A 30VDC L/R =0ms at 85°C
			5A 250VAC COSØ=1 at 70°C 5A 30VDC L/R =0ms at 70°C

Notes: 1) All values unspecified are at room temperature.

2) Only typical loads are listed above. Other load specifications can be available upon request.



HONGFA RELAY

ISO9001, IATF16949, ISO14001, ISO45001, IECQ QC 080000, ISO/IEC 27001 CERTIFIED

2024 Rev. 1.00

## ORDERING INFORMATION

Type	HF49FD / 012 -1H 1 2 G T F L (XXX)						
Coil voltage	5, 6, 9, 12, 18, 24VDC						
Contact arrangement	1H: 1 Form A						
Contact version	1: Single contact 2: Bifurcated contact(Only for gold plated)						
Space between terminals	(See the following) 1: 5.08mm 2: 7.62mm						
Contact plating	G: Gold plated Nil: No gold plated (Only for single contact)						
Contact material	T: AgSnO <sub>2</sub> (Only for single contact) Nil: AgNi						
Insulation standard	F: Class F B: Class B Nil: Class A						
Coil power	L: Sensitive (Only for 24VDC) Nil: Standard						
Special code <sup>2)</sup>	XXX: Customer special requirement Nil: Standard						

- Notes:** 1) Contact is recommended for suitable condition and specifications if water cleaning or surface process is involved in assembling relays on PCB.  
 2) The customer special requirement express as special code after evaluating by Hongfa.  
 3) If customer need to fix HF49FD in 49F socket (HF49FD+49F socket) in application, please choose HF49FD relay with suffix (009) or suffix (086).  
 4) Standard tube packing length is 546mm. Any special requirement needed, please contact us for more details.  
 5) For products that should meet the explosion-proof requirements of "IEC 60079 series", please note [Ex] after the specification while placing orders. Not all products have explosion-proof certification, so please contact us if necessary, in order to select the suitable products.

## OUTLINE DIMENSIONS, WIRING DIAGRAM AND PC BOARD LAYOUT

### Outline Dimensions

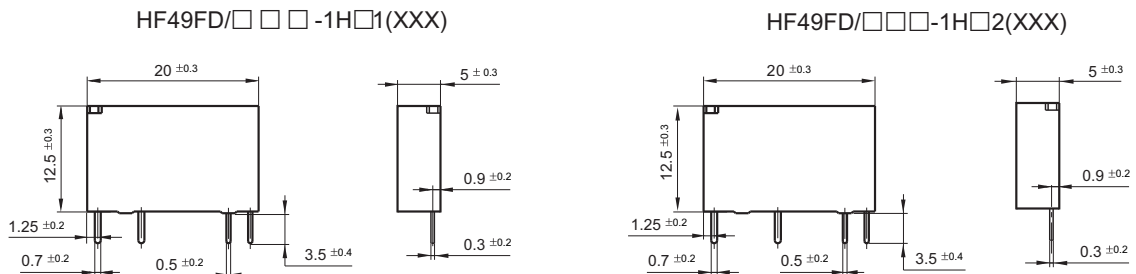

### PCB Layout (Bottom view)

HF49FD/□□□-1H□1(XXX)

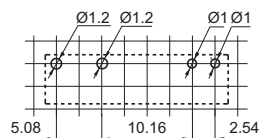

HF49FD/□□□-1H□2(XXX)

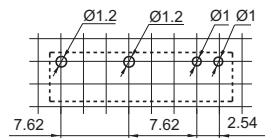

### Wiring Diagram (Bottom view)



- Remark:** 1) In case of no tolerance shown in outline dimension: outline dimension  $\leq 1$ mm, tolerance should be  $\pm 0.2$ mm; outline dimension  $> 1$ mm and  $\leq 5$ mm, tolerance should be  $\pm 0.3$ mm; outline dimension  $> 5$ mm, tolerance should be  $\pm 0.4$ mm.  
 2) The tolerance without indicating for PCB layout is always  $\pm 0.1$ mm.  
 3) The width of the gridding is 2.54mm.

## CHARACTERISTIC CURVES

MAXIMUM SWITCHING POWER

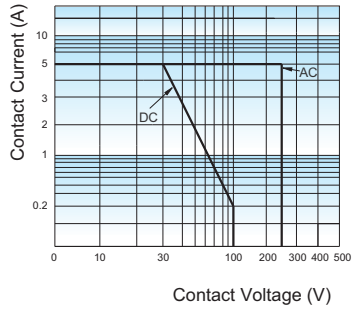

ENDURANCE CURVE

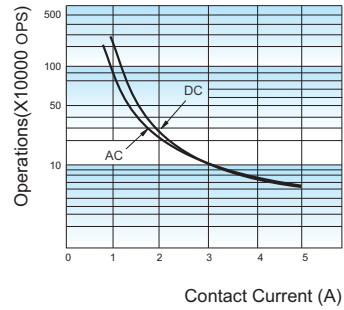

**Test conditions:**

1H1 type: AgNi, Resistive load, 250VAC/30VDC, Room temp., 1s on 9s off.

COIL TEMPERATURE RISE

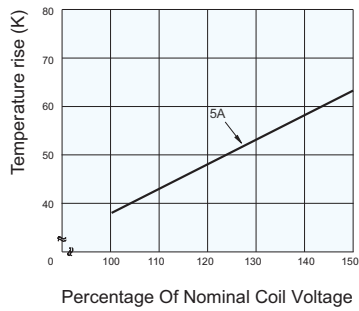

**Test conditions:**

5A 85°C  
(Typical curve of 24VDC standard type)

ELECTRICAL ENDURANCE CURVE OF INDUCTIVE LOAD

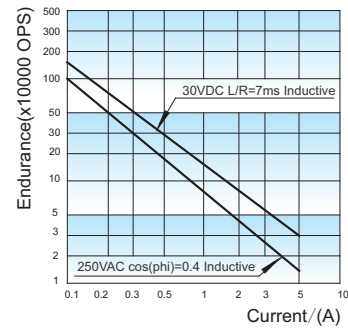

**Test conditions:**

1H1: Room temp, 1s on 9s off.

**Disclaimer**

The specification is for reference only. See to "Terminology and Guidelines" for more information. Specifications subject to change without notice.. We could not evaluate all the performance and all the parameters for every possible application. Thus the user should be in a right position to choose the suitable product for their own application. If there is any query, please contact Hongfa for the technical service. However, it is the user's responsibility to determine which product should be used only.

© Xiamen Hongfa Electroacoustic Co., Ltd. All rights of Hongfa are reserved.