

Specifications



Contactor, UEC1-400F, 3P (3NO), DC Coil

Main

Product Series	UEC1		
Product or Component Type	Contactor		
Device Short Name	UEC1-400F		
Contactor Application	Motor control Resistive load		
Utilisation Category	AC-3 AC-4 AC-1		
Poles Description	3P		
[Ue]Rated Operational Voltage	Power circuit: ≤ 690 V AC 50/60Hz		
[Ie]Rated Operational Current	400 A (at ≤ 40 °C) at ≤ 400 V AC AC-3 for power circuit 500 A (at ≤ 40 °C) at ≤ 690 V AC AC-1 for power circuit		
[Us] Control Circuit Voltage	Voltage (VDC): 48 110 220 Code: ED FD MD		

Complementary

Motor Power kW	110 kW at 220/240 V AC 50/60 Hz (AC-3) 200 kW at 380/400 V AC 50/60 Hz (AC-3) 220 kW at 415 V AC 50/60 Hz (AC-3) 250 kW at 440 V AC 50/60 Hz (AC-3) 257 kW at 500 V AC 50/60 Hz (AC-3) 280 kW at 660/690 V AC 50/60 Hz (AC-3)
Pole Contact Composition	3 NO
[Ith] Conventional Free Air Thermal Current	400 A (at ≤ 40 °C) for power circuit
[Icw] Rated Short-Time Withstand Current	3600 A ≤ 40 °C - 10 s for power circuit 2400 A ≤ 40 °C - 30 s for power circuit 1700 A ≤ 40 °C - 1 min for power circuit 1200 A ≤ 40 °C - 3 min for power circuit

	1000 A ≤ 40 °C - 10 min for power circuit
Associated Fuse Rating	500 A gG at ≤ 400 V coordination type 2 for power circuit
Average Impedance	0.26 m Ω - Ith 50 Hz for power circuit
[Ui] Rated Insulation Voltage	Power circuit: 1000 V conforming to IEC 60947-4-1
Overvoltage Category	III
Pollution Degree	3
[Uimp] Rated Impulse Withstand Voltage	8 kV conforming to IEC 60947
Mechanical Durability	1 M cycles
Electrical Durability	0.3 M cycles 400 A AC-3 at $U_e \leq 400$ V
Control Circuit Type	DC
Control Circuit Voltage Limits	0.85...1.1 Us (-5...40 °C): operational 0.1...0.75 Us (-5...40 °C): drop-out
Inrush Power in VA	920...1140 VA (at 25 °C)
Hold-in Power Consumption in VA	4.0...7.5 VA (at 25 °C)
Operating Time	50...65 ms closing, 45...65 ms opening
Maximum Operating Rate	Electrical: 300 cycs/h Mechanical: 1000 cycs/h
Connections - Terminals	Power circuit lugs-ring terminals 2 x 150 mm ² Power circuit bar 2 30 x 5 mm Power circuit bolted connection M10 Control circuit: screw clamp terminals 1 1...4 mm ² (AWG 18...12) - cable stiffness: flexible without cable end Control circuit: screw clamp terminals 2 1...4 mm ² (AWG 18...12) - cable stiffness: flexible without cable end Control circuit: screw clamp terminals 1 1...4 mm ² (AWG 18...12) - cable stiffness: flexible with cable end Control circuit: screw clamp terminals 2 1...2.5 mm ² (AWG 18...14) - cable stiffness: flexible with cable end Control circuit: screw clamp terminals 1 1...4 mm ² (AWG 18...12) - cable stiffness: solid without cable end Control circuit: screw clamp terminals 2 1...4 mm ² (AWG 18...12) - cable stiffness: solid without cable end
Tightening Torque	Power circuit: 310 lb.in (35 N·m)- on bolt locking terminals - with external hexagonal wrench 16 Control circuit: 11 lb.in (1.2 N·m)- on screw clamp terminals - with screwdriver flat \varnothing 6 mm Control circuit: 11 lb.in (1.2 N·m)- on screw clamp terminals - with screwdriver Philips No 2
Mounting Support	Screw

Environment

Standards	GB/T 14048.4, IEC/EN 60947-4-1, BS EN 60947-4-1
Product Certifications	CCC, CE, UKCA

IP Degree of Protection	IP00 front face conforming to IEC 60529
Permissible Ambient Air	-5...40 °C for normal operating
Temperature Around the Device	40...70 °C with derating (for operation in the range of Us...1.1Us) Storage: -60...80 °C
Operating Altitude	0...3000 m without derating
Fire Resistance	Current-carrying parts: 850 °C conforming to IEC 60695-2-11
Height	209 mm
Width	213 mm
Depth	219 mm
Net Weight	8.50 kg

Packing Units

Unit Type of Package 1	1 box
Number of Units in Package 1	1 pcs
Package 1 Height	25.5 cm
Package 1 Width	24.7 cm
Package 1 Length	29.0 cm
Package 1 Weight	9.50 kg
Unit type of Package 2	1 carton
Number of Units in Package 2	2 pcs
Package 2 Height	28.0 cm
Package 2 Width	32.0 cm
Package 2 Length	52.0 cm
Package 2 Weight	19.0 kg

Offer Sustainability

EU RoHS Directive	Conforming
Mercury Free	Yes
China RoHS Regulation	Conforming
RoHS Exemption Information	Yes

Contractual Warranty

Warranty	18 months
----------	-----------

Dimensions

UEC1-400F (3P, DC coil)

AC contactor:

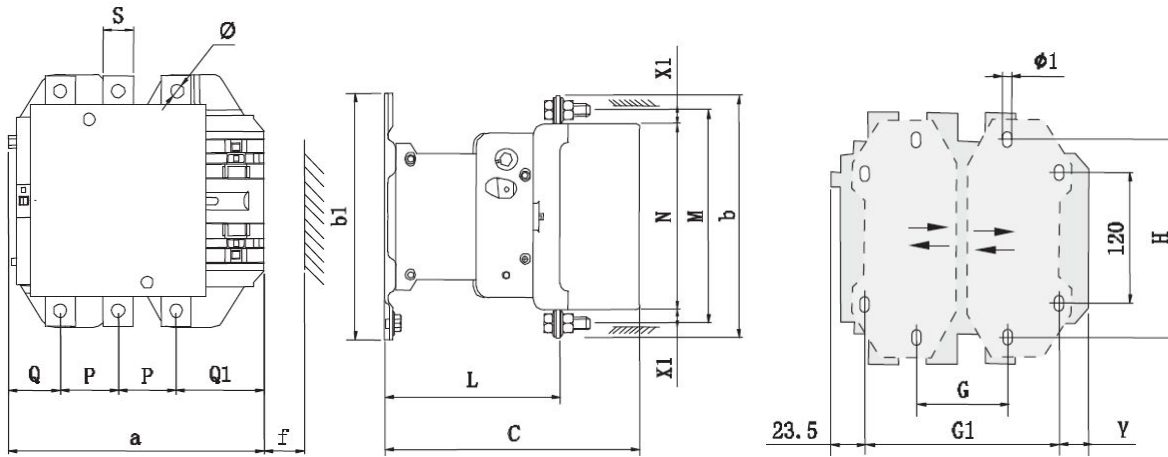

	UEC1-400F
a	213
P	48
Q	43
Q1	74
S	25
Φ	M10
f	151
b	206
b1	209
M	181
N	158
C	219
L	145
G	80(66 ~ 102)
G1	170(156 ~ 192)
Φ1	8.5
H	180
Y	19.5
X1	15 ($U_e \leq 500V$)、20 ($U_e > 500V$)

Note: Unit: mm

f: Minimum distance required for coil removal.

X1: Minimum electrical clearance according to operational voltage and breaking capacity.

Wiring diagram

AC contactor

3P

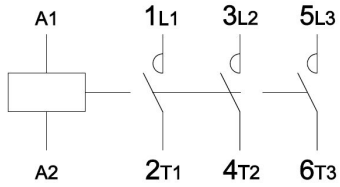

Top mounting auxiliary contact block (instantaneous auxiliary contact)

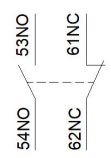
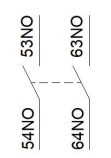
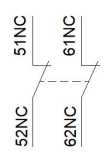
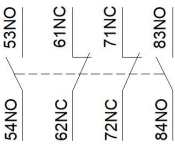
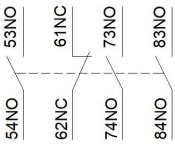
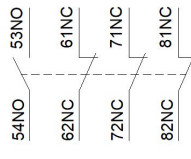
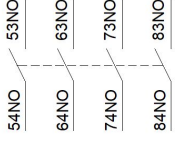
<p>CA1R11 (1NO1NC)</p> 	<p>CA1R20 (2NO)</p> 	<p>CA1R02 (2NC)</p> 
<p>CA1R22 (2NO2NC)</p> 	<p>CA1R31 (3NO1NC)</p> 	<p>CA1R13 (1NO3NC)</p> 
<p>CA1R40 (4NO)</p> 	<p>CA1R04 (4NC)</p> 