

Specifications



Contactor, UEC1-12C, 3P (3NO), AC Coil

Main

Product Series	UEC1
Product or Component Type	Contactor
Device Short Name	UEC1-12C
Contactor Application	Motor control Resistive load
Utilisation Category	AC-3 AC-4 AC-1
Poles Description	3P
Rated Operational Voltage [Ue]	Power circuit: ≤ 690 V AC 50/60Hz
Rated Operational Current [Ie]	12 A (at ≤ 60 °C) at ≤ 400 V AC AC-3 for power circuit 25 A (at ≤ 60 °C) at ≤ 690 V AC AC-1 for power circuit
[Us] Control Circuit Voltage (AC 50/60Hz)	Voltage (V): 24 36 42 48 110 115 127 220 230 240 380 400 415 Code: B7 CC7 D7 E7 F7 FE7 FC7 M7 P7 U7 Q7 V7 N7

Complementary

Motor Power kW	3 kW at 220/230 V AC 50/60 Hz (AC-3) 5.5 kW at 380/400 V AC 50/60 Hz (AC-3) 7.5 kW at 660/690 V AC 50/60 Hz (AC-3)
Motor Power hp	1 hp at 110...120 V AC 50/60 Hz for 1 phase motors 2 hp at 200...208 V AC 50/60 Hz for 1 phase motors 2 hp at 220...240 V AC 50/60 Hz for 1 phase motors 3 hp at 200...208 V AC 50/60 Hz for 3 phases motors 3 hp at 220...240 V AC 50/60 Hz for 3 phases motors 7.5 hp at 440...480 V AC 50/60 Hz for 3 phases motors

10 hp at 550...600 V AC 50/60 Hz for 3 phases motors

Pole Contact Composition	3 NO
Conventional Free Air Thermal Current [I _{th}]	25 A (at ≤60 °C) for power circuit 10 A (at ≤60 °C) for signalling circuit
Rated Short-Time Withstand Current [I _{cw}]	105 A ≤40 °C - 10 s for power circuit 210 A ≤40 °C - 1 s for power circuit 30 A ≤40 °C - 10 min for power circuit 61 A ≤40 °C - 1 min for power circuit
Associated Fuse Rating	10 A gG for signalling circuit conforming to IEC 60947-5-1 25 A gG at ≤ 690 V coordination type 2 for power circuit
Average Impedance	2.7 mΩ - I _{th} 50 Hz for power circuit
[U _i] Rated Insulation Voltage	Power circuit: 690 V conforming to IEC 60947-4-1 Power circuit: 600 V UL Certified Signalling circuit: 690 V conforming to IEC 60947-5-1 Signalling circuit: 600 V UL Certified
Overvoltage Category	III
Pollution Degree	3
[U _{imp}] Rated Impulse Withstand Voltage	6 kV conforming to IEC 60947
Mechanical Durability	10 M cycles
Electrical Durability	1.2 M cycles 12 A AC-3 at U _e ≤ 400 V
Control Circuit Type	AC at 50/60 Hz standard
Coil Technology	Without built-in suppressor module
Control Circuit Voltage Limits	0.8...1.1 U _s (-40...60 °C): operational AC 50 Hz 0.85...1.1 U _s (-40...60 °C): operational AC 60 Hz 1...1.1 U _s (60...70 °C): operational AC 50/60 Hz 0.2...0.75 U _s (-40...70 °C): drop-out AC 50/60 Hz
Inrush Power in VA	75 VA 50/60 Hz (at 25 °C)
Hold-in Power Consumption in VA	9.5 VA 50/60 Hz (at 25 °C)
Operating Time	Power circuit: 12...22 ms closing, 4...19 ms opening Signalling circuit (NO): 15...26 ms closing, 4...19 ms opening Signalling circuit (NC): 4...19 ms opening, 12...32 ms closing
Maximum Operating Rate	Electrical: 750 cycs/h Mechanical: 3600 cycs/h
Connections - Terminals	Power circuit: screw clamp terminals 1 1...6 mm ² (AWG 18...10)- cable stiffness: flexible without cable end Power circuit: screw clamp terminals 2 1...6 mm ² (AWG 18...10)- cable stiffness: flexible without cable end

	<p>Power circuit: screw clamp terminals 1 1...6 mm² (AWG 18...10)- cable stiffness: flexible with cable end</p> <p>Power circuit: screw clamp terminals 2 1...4 mm² (AWG 18...12)- cable stiffness: flexible with cable end</p> <p>Power circuit: screw clamp terminals 1 1...6 mm² (AWG 18...10)- cable stiffness: solid without cable end</p> <p>Power circuit: screw clamp terminals 2 1...6 mm² (AWG 18...10)- cable stiffness: solid without cable end</p> <p>Control circuit: screw clamp terminals 1 1...4 mm² (AWG 18...12)- cable stiffness: flexible without cable end</p> <p>Control circuit: screw clamp terminals 2 1...4 mm² (AWG 18...12)- cable stiffness: flexible without cable end</p> <p>Control circuit: screw clamp terminals 1 1...4 mm² (AWG 18...12)- cable stiffness: flexible with cable end</p> <p>Control circuit: screw clamp terminals 2 1...2.5 mm² (AWG 18...14)- cable stiffness: flexible with cable end</p> <p>Control circuit: screw clamp terminals 1 1...4 mm² (AWG 18...12)- cable stiffness: solid without cable end</p> <p>Control circuit: screw clamp terminals 2 1...4 mm² (AWG 18...12)- cable stiffness: solid without cable end</p>
Tightening Torque	<p>Power circuit: 13 lb.in (1.5 N·m) - on screw clamp terminals - with screwdriver flat Ø 6 mm</p> <p>Power circuit: 13 lb.in (1.5 N·m) - on screw clamp terminals - with screwdriver Philips No 2</p> <p>Control circuit: 11 lb.in (1.2 N·m) - on screw clamp terminals - with screwdriver flat Ø 6 mm</p> <p>Control circuit: 11 lb.in (1.2 N·m) - on screw clamp terminals - with screwdriver Philips No 2</p>
Auxiliary Contact Composition	1NO1NC, 2NO2NC, other combinations can be customized
Minimum Switching Voltage	24 V for signalling circuit
Minimum Switching Current	0.1A for signalling circuit
Insulation Resistance	> 10 MΩ for signalling circuit
Mounting Support	Screw 35mm DIN Rail

Environment

Standards	<p>GB/T 14048.4, GB/T 14048.5, IEC/EN 60947-4-1, IEC/EN 60947-5-1, BS EN 60947-4-1, BS EN 60947-5-1, UL 60947-4-1, UL 60947-5-1</p>
-----------	---

Product Certifications	CCC, CE, UKCA, VDE, UL (cULus LISTED)
IP Degree of Protection	IP20 front face conforming to IEC 60529
Permissible Ambient Air Temperature Around the Device	-40...60 °C for normal operating 60...70 °C with derating (for operation in the range of Us...1.1Us) Storage: -60...80 °C
Operating Altitude	0...3000 m without derating
Fire Resistance	Current-carrying parts: 850 °C conforming to IEC 60695-2-11
Height	90 mm
Width	45 mm
Depth	96 mm
Net Weight	0.42 kg

Packing Units

Unit Type of Package 1	1 box
Number of Units in Package 1	1 pcs
Package 1 Height	10.4 cm
Package 1 Width	5.0 cm
Package 1 Length	9.5 cm
Package 1 Weight	0.48 kg
Unit type of Package 2	1 carton
Number of Units in Package 2	30 pcs
Package 2 Height	25.0 cm
Package 2 Width	29.0 cm
Package 2 Length	32.5 cm
Package 2 Weight	14.40 kg

Offer Sustainability

REACH Regulation	Conforming
EU RoHS Directive	Conforming
Mercury Free	Yes
China RoHS Regulation	Conforming
RoHS Exemption Information	Yes

Contractual Warranty

Warranty	18 months
----------	-----------

Dimensions

UEC1-09~18 (3P, AC coil)

AC Contactor:

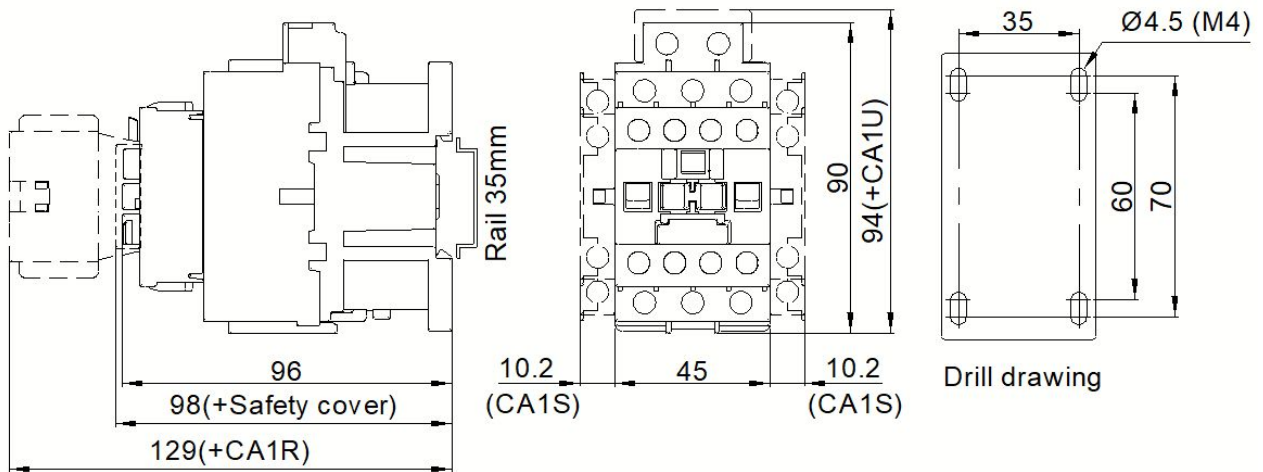

Interlock Contactor:

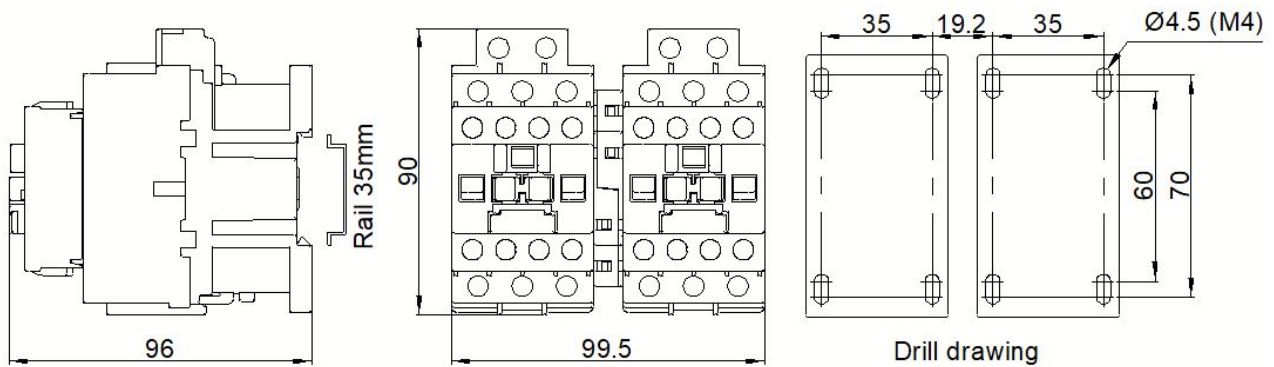

Note: The unit is mm. The tolerance for mounting holes: ± 0.5 ; for other external dimensions: ± 1.5 , unless otherwise specified.

Wiring Diagram

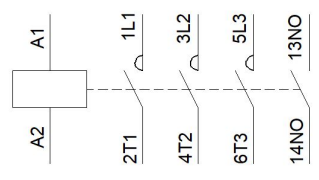
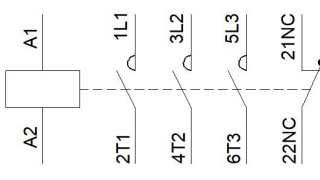
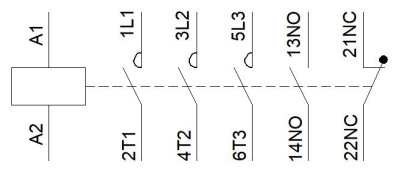
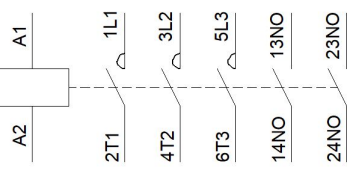
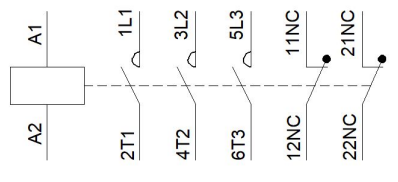
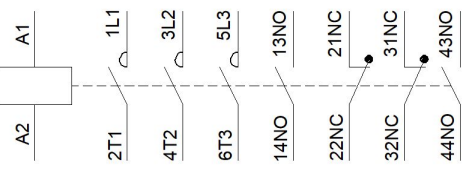
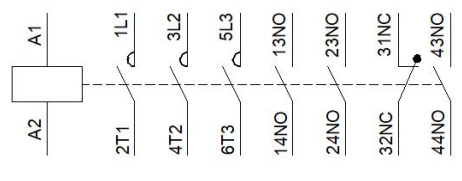
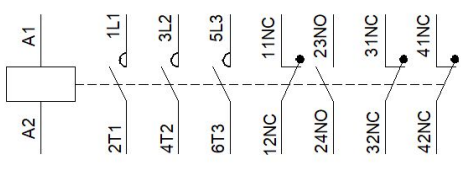
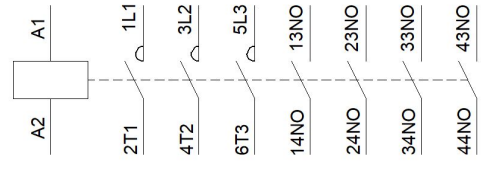
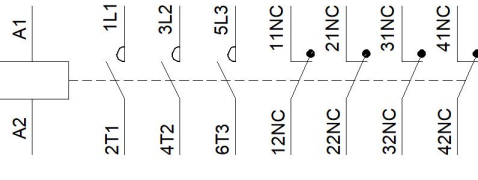
AC contactor	
<p>3P+1NO</p> 	<p>3P+1NC</p> 
<p>3P+1NO1NC</p> 	<p>3P+2NO</p> 
<p>3P+2NC</p> 	<p>3P+2NO2NC</p> 
<p>3P+3NO1NC</p> 	<p>3P+1NO3NC</p> 
<p>3P+4NO</p> 	<p>3P+4NC</p> 

Top mounting auxiliary contact block (instantaneous auxiliary contact)

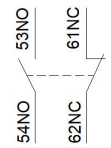
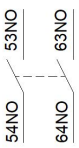
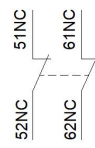
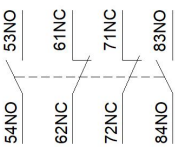
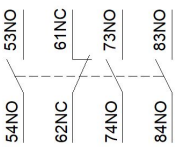
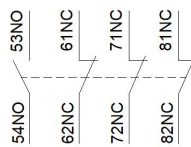
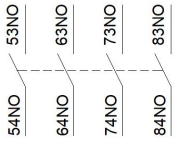
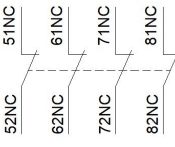
<p>CA1R11 (1NO1NC)</p> 	<p>CA1R20 (2NO)</p> 	<p>CA1R02 (2NC)</p> 
<p>CA1R22 (2NO2NC)</p> 	<p>CA1R31 (3NO1NC)</p> 	<p>CA1R13 (1NO3NC)</p> 
<p>CA1R40 (4NO)</p> 	<p>CA1R04 (4NC)</p> 	

Side mounting auxiliary contact block (instantaneous auxiliary contact)

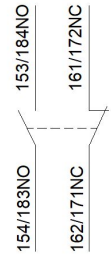
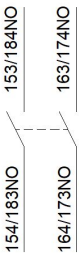
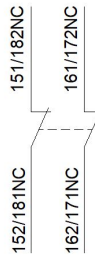
<p>CA1S11 (1NO1NC)</p> 	<p>CA1S20 (2NO)</p> 	<p>CA1S02 (2NC)</p> 
--	---	---